



West Bengal State Electricity Distribution Company Limited

(A West Bengal Government Enterprise)

Regional Office: North 24 Parganas

Administrative Building, Vivek Nagar, B.T. Road, P.S. Khardah

District: North 24 Parganas, Pin 700119

Telephone: (033) 2592 0353 / 0591 :: e-mail: rm.north24pgs@wbasedcl.in

NOTICE INVITING e-TENDER

NIT No: RM/24PNR/ELEC/2024-25/02

Date: 29.07.2024

The Regional Manager, North 24 Parganas Region, WBSEDCL invites e-tender at the Office of the Regional Manager, North 24 Parganas Region, WBSEDCL at Administrative Building, Vivek Nagar, B.T. Road, P.S. - Khardah, District - North 24 Parganas, Pin – 700119 for the work detailed in the table below.

(Submission of Bid through Online)

Sl. No.	Name of the Work	Estimated Amount (Rs.)	Earnest Money Deposit (Rs.)	Period of Completion
01.	Laying of 11 KV, 3Cx95 sq.mm. XLPE UG Cable [R.L. 1.190 Km] for effecting new bulk connection i.r.o. M/s. Prabhuji Concrete at Chandipur under Baduria Division, District North 24 Parganas.	3,55,246.00 (Three lakh fifty five thousand two hundred forty six only)	@2% of the estimated cost to be submitted online	30 (Thirty) days from the day of handover of site

- (1) For e-filling of tender, intending bidder may download the tender documents from the website <https://wbtenders.gov.in> directly with the help of Digital Signature Certificate (DSC).
- (2) Both Technical Bid and Financial Bid should be submitted in technical and financial folder concurrently and duly digitally signed by the prospective bidder through the website <https://wbtenders.gov.in>.
- (3) Technical Document and Financial Bid should be submitted online on or before the 'Date & Time Schedule' stated in Serial Number (10).
- (4) The FINANCIAL OFFER of the prospective bidder will be considered only if the TECHNICAL DOCUMENT is found qualified by the Tender Inviting Authority. The decision of the Tender Inviting Authority will be final and absolute in this respect. The list of Responsive and Non-Responsive Bidders will be displayed in the website.

(5) The bid so prepared by the bidder and all other correspondences and documents relating to the bid, exchanged by the bidder and WBSEDCL, shall be written in English Language only.

(6) Eligibility criteria for participation in the tender:

- (i) The bidders must be bonafide, experienced & resourceful contractors and have successfully completed similar nature of work under the authority of Government, Semi-Government, Government Undertaking Organizations, Government Enterprises or any power utility etc.
- (ii) The Bidders are required to produce valid copies of current G.S.T. registration certificate, professional tax (P.T.) deposit challan, E.P.F. registration certificate & challan, E.S.I. registration certificate & challan, PAN card, income tax acknowledgement / return for the last three financial years, trade license as well as other certificates of compliance of statutory obligations (to be documented through e-filing).
- (iii) The Bidders shall submit reports on the financial standing reflecting solvency of bidder (company / firm) as certified by bankers, audited annual reports on accounts with auditor's certificate, Tax audit report for last three financial years, as applicable.

Prospective bidders are advised to note carefully the minimum qualification criteria as mentioned in the Table - I of Serial Number (4) (Submission of Tenders) of Section - A (INSTRUCTION TO BIDDERS).

(7) Responsibility of Bidders:

- (i) It shall be the sole responsibility of Bidders to determine and to satisfy themselves by such means as they consider necessary or desirable for all matters pertaining to this contract including, in particular, all factors that may affect the cost, duration and execution of the work.
- (ii) It must be understood and agreed that such factors have properly been investigated and considered while submitting the bid. Any claim, whatsoever, including those for financial adjustments to the contract, once awarded under these documents will not be entertained by WBSEDCL. Neither any change in time schedule of the contract nor any financial adjustments, arising thereof, shall be permitted by WBSEDCL, which are based on the lack of such clear information of its effect.
- (iii) WBSEDCL will not assume any responsibility regarding information gathered, interpretations or conclusions made by the bidder or regarding information, interpretation or deductions the bidder may derive from the data furnished by WBSEDCL. Verbal agreement or conversation with any officer, employee of WBSEDCL either before or after the execution of the contracts, shall not affect or modify any of the terms or obligations contained in the contract.
- (iv) The bid shall include all the information as per bid document. The bidder is expected to examine carefully all instruction, conditions, forms, schedules, terms, Annexure, specifications etc. in the bidding documents. Failure to comply with the requirement of bid submission will be at the bidders own risk. Bids, which are determined to be not substantially responsive to the requirements of the bidding documents, will be rejected.
- (v) The bidder shall bear all the costs associated with the preparation and submission of bid and WBSEDCL in no case shall be responsible or liable for these costs, regardless of the conduct or outcome of the bidding process.

(vi) In order to avoid any problem arising out of network error or server error, bidders are advised to submit the bid, well in advance of the last date and time of submission of the bid. WBSSEDCL shall not be held responsible for any failure of Bid submission due to snag arising out of network failure.

(8) **Mobilisation Advance:** No mobilisation advance or secured advance will be allowed.

(9) **Validity of Bids:** Bids shall remain valid for a period not less than **120 (One hundred twenty) days** after date of opening of bids of the tender. Bids valid for a shorter period shall be rejected by the Tender Inviting Authority as non-responsive. If the bidder withdraws the bid before the period of bid validity without giving any satisfactory explanation for such withdrawals, the earnest money as deposited will be forfeited forthwith without assigning any reason thereof.

(10) **Schedule of Key Dates & Time:**

Sl. No.	Particulars	Date & Time
01.	Date of uploading of N.I.T and Tender Documents (online). [Publishing date]	29.07.2024 after 10.00 Hrs
02.	Documents Download Start date (online).	29.07.2024 after 10.00 Hrs
03.	Bid Submission Start date (online)	29.07.2024 after 10.00 Hrs
04.	Bid Submission End date (online)	12.08.2024 up to 15.00 Hrs
05.	Last date of Online deposition of EMD	12.08.2024 up to 15.00 Hrs
06.	Technical bid opening date (online)	14.08.2024 after 15.00 Hrs
07.	Date of uploading the Final List of Technically Qualified Bidders after Technical Bid Evaluation (online).	To be intimated later.
08.	Financial Bid opening date (online).	To be intimated later.

(11) **Earnest Money Deposit (EMD):**

The amount of Earnest Money Deposit (EMD) shall be deposited **through Online** as prescribed in the NIT. The bidder shall select the tender to bid and initiate payment of EMD.

(a) Following payment options are available for paying EMD amount through

Online mode:

- **Net-banking through payment Gateway.**
- **RTGS / NEFT Payment:** On selection of RTGS/NEFT as the payment mode, the e-Procurement portal will show a pre-filled challan having the details to process RTGS/NEFT transaction. The bidder will print the challan and use the prefilled information to make RTGS/NEFT payment using his bank account. Once the payment is made, the bidder will come back to the e-procurement portal to continue the bidding process after expiry of a reasonable time to enable the RTGS/NEFT process to be completed.

(b) **General Instruction for Online Payment:**

- The bidder will have to mandatorily pay through Net-banking facility once Net-banking mode is opted for payment.

- Status of NEFT/RTGS payment through challan for a bid may take time for bank settlement which is updated in 24 Hrs. (approx.). As such bidders opting to pay through NEFT/RTGS mode shall make payment well before 24 Hrs. to avoid any complicity.
- In case actual EMD amount as per NIT is more than the one shown in E-tender Portal, bidders will have to opt for NEFT/RTGS mode (challan mode). In that case the total actual EMD amount is to be paid only through NEFT/RTGS mode (challan mode).
- The bank account used for payment of EMD by the bidders shall be maintained operative until the completion of tendering process. All refunds will be made mandatorily to the Bank A/c from which the payment of EMD has been initiated.

(c) **Refund /Settlement of EMD Amount:**

- For unsuccessful bidders, EMD amount submitted against the tender shall be refunded automatically, through an automated process, by NIC portal on receipt of updated status of any bid.
- For successful bid(s), EMD will be refunded from WBSEDCL authority after completion of tendering process and following due procedures.
- The bank account used for payment of EMD by the bidders shall be maintained operative until the completion of tendering process. All refunds will be made mandatorily to the Bank A/c from which the payment of EMD has been initiated.
- For any queries related to payment and refunds, bidders will have to communicate with ICICI Customer Support, viz. 033 4026 7512 / 13 since payment gateway facility used by E-tender portal is maintained by ICICI.

(d) Successful bidder(s) shall have to mandatorily **create Vendor ID through WBSEDCL Web Portal Vendor Corner**, if not created earlier.

(e) **Forfeiture of Earnest Money Deposit (EMD):** Earnest money deposit / bid guarantee shall be forfeited in case of the following situations:

- If during the period of validity, the bidder withdraws / modifies its bid as a whole or in part.
- If the bidder deviates from any clarification/confirmation given by him sub-sequent to submission of his bid.
- In the case of successful bid, if the bidder fails:
 - To accept LOA / Order unconditionally and sign contract.
 - To furnish contract performance bond as per standard proforma.

(12) **Specification of Work:** The work should conform to WBSEDCL's general conditions of contract, standard specifications, and approved drawings of WBSEDCL satisfying relevant provisions of I.E. rules.

(13) **Supply of Materials:** Major items of necessary equipment and materials shall be supplied by the WBSEDCL from the nearest site stores. In excess of 35 (thirty five) km, only cost of transport of excess kilometers beyond 35 (thirty five) km will be payable as per approved rate schedule of the WBSEDCL prevailing at the time of actual transport.

- (14) **Tools & Tackles**: Adequate quantities of standard tools and tackles shall be available so as to complete the work entrusted as expeditiously as possible.
- (15) **Penalty for delay in Completion**: In case of failure to complete the work within time, penalty from ½% to 2.5% (depending upon the nature of non performance) of the executed work within the stipulated rate @ ½% for every fortnight shall be liable for payment.
- (16) **Site Visit**: The Bidder, at his own responsibility and risk is encouraged to visit and examine the site of works and its surroundings and obtain all information that may be necessary for preparing Bid and entering into an agreement for the work / works as mentioned in the NIT, before submitting offer with full satisfaction. The costs for visiting the working site shall be at the bidder's own expense.
- (17) **Right to reject Bids**: WBSEDCL reserves the right to accept or reject any bid and to annul the bidding process and reject all bids at any time prior to award of the Order, without thereby incurring any liability to the affected bidder or bidders or any obligation to inform the affected bidder or bidders the reason for WBSEDCL's action.
- (18) **Controlling Officer**: The **Divisional Manager, Baduria Division**, WBSEDCL shall act as Controlling Officer.
- (19) **Supervising Officer & Site-in-Charge**: The **Divisional Engineer (Technical), Baduria Division**, WBSEDCL shall act as Supervising Officer & Site-in-Charge.
- (20) **Paying Authority**: The **Assistant Manager (F&A), Baduria Division**, WBSEDCL shall be the Paying Authority.
- (21) Work Order & Payment of work will depend on availability of fund. Intending bidders may consider this criteria while submission of tender and quoting their rate through online.
- (22) No Conditional Bid / Incomplete Tender will be accepted under any circumstances.
- (23) The intending bidder(s) are required to quote the rate (percentage above / below / at par) over the total estimated cost put to tender online considering that no escalation and / or price adjustment will be allowed by the department under any circumstances and to consider the following costs and criteria & conditions.
- The quoted rates shall include, wherever applicable, cost of cement, sand, brick bats, brick ballast, all sort of M.S. items and G.I. nuts, bolts, studs & washers of approved brand and quality, socketing of cables, ferrule for control cable, eye bolts etc.
 - Rates will also include fabrication cost of all M.S. sections which will be supplied by WBSEDCL for making clamps and other fittings except fabrication of V Bracket and Top Adopter.
 - All M.S. items supplied from the Store of WBSEDCL will be fabricated by the contractor. After fabrication, the fabricated items are to be galvanized by the contractor (if scope is mentioned in BOQ). Necessary supervision & testing will be made by the Engineers of the WBSEDCL at the workshop of galvanizing plant as per IS 2633: 1986.

- **The cost of transportation of MS fabricated items to and from the workshop where galvanization will be done, will be borne by the Contractor which is to be included in the quoted rate.**
- (24) At any stage during scrutiny, if it is found that the credential or any other papers which the Bidder uploaded during Bidding process is/are incorrect / manufactured / fabricated / misleading, that bid will be considered as nonresponsive and outright rejected with forfeiture of Earnest Money Deposit and action will be taken as per stipulations of Information Technology Act & Rules and other admissible law, as in force.
- (25) Before issuance of Letter of Acceptance / Work order, the tender accepting authority may verify the credential & other documents of the lowest bidder so uploaded online if found necessary. If it is found such document incorrect / manufactured / fabricated, Letter of Acceptance / Work order will not be issued in favor of the bidder under any circumstances and action will be taken accordingly. If any bidder fails to produce the original hard copies of the document like Successful Completion Certificate and any other documents on demand of the department within a specified time frame or if any deviation is detected in the original copies from the uploaded soft copies, it may be treated as submission of false documents by the bidder and action may be referred to the appropriate authority for prosecution as per relevant IT Act.
- (26) The Tender Inviting Authority reserves the right to cancel the NIT due to unavoidable circumstances and no claim in this respect will be entertained.
- (27) The WBSEDCL shall not bind itself to accept the lowest tender and reserves the right to accept or reject any bid and to annul the bidding process and reject all bids at any time prior to the Award of Contract without thereby incurring any liability to the affected bidder or bidders or any obligation to inform the affected bidder or bidders of the ground for WBSEDCL (Tender Accepting Authority)'s action.
- (28) Canvassing in connection with tenders is strictly prohibited and the tenders submitted by the contractors, who resort to canvassing will be liable to rejection. Any evidence of unfair trade practices, including overcharging, price fixing, cartelisation etc. as defined in various statutes, will automatically disqualify the parties. Evidence of repeated occurrence of such malpractices by any bidder shall be viewed seriously by the WBSEDCL authority and appropriate penal measures shall be imposed on such bidders which may include blacklisting.
- (29) **LOSS AND DAMAGE OF MATERIALS:** The contractor shall be responsible for safe custody of all materials until the installation is officially taken over by the Company. For any loss including theft/pilferage/damage during the period of transportation, storage, erection, jointing, reinstatement etc. the same shall be made good by the contractor at his own cost and arrangement.
- (30) **STORAGE CUM ERECTION INSURANCE:** "Loss" mentioned in serial number (27), shall also include theft. In case of any theft, the contractor shall lodge FIR with the Police Station within 24 hours of occurrence of the incident with intimation to the Site Engineer with copy of the FIR. The contractor shall obtain Insurance Policy for all such materials which shall be issued by the Company for the erection of cable and other installation works from the time of taking over the materials from the

Company up to the time of taking over of the completed installation work by the Company. The contractor will obtain Insurance in the name of "WEST BENGAL STATE ELECTRICITY DISTRIBUTION COMPANY LIMITED" with a General Insurance Company. In the event of any loss / damage or both, the contractor shall lodge claim with the Insurance Company and take necessary measures to realize claim from them on behalf of WBSEDCL. The payment received from the Insurance Company against such loss / theft shall be deposited to WBSEDCL.

However, for timely completion of work, the materials may be issued to the contractor by the company against a receipt of fresh requisition from the contractor on that effect. In spite of the insurance being made by the contractor, some special security arrangement will have to be ensured by the contractor to prevent theft of company's property during storage / erection / installation and the cost of such arrangement shall be borne by the contractor. It may be noted that neither any materials can be issued by the company nor the contractor will be allowed to take up the work unless the insurance coverage is obtained. The contractor at his own cost shall make adequate arrangement to safeguard the materials. Such arrangement shall be maintained round the clock along the entire stretch to eliminate any attempt of damage / pilferage of materials already utilized by them. The damages required to be covered under the insurance shall include, fire and allied risk, miscellaneous accidents, erection risk, workman compensation risk, loss or damage in transit, theft, pilferage etc. as per the project requirement.

All cost on account of insurance liabilities covered under the contract will be to the contractor's account. It is the responsibility of the contractor to keep the policy alive throughout the desired period and adequate premium should be paid by them time to time. The policy should cover the material and labour cost of the entire contract. The insurance policy has to be handed over to the ordering authority before first lot of material is issued to the contractor.

- (31) Civil and Electrical activities which are not covered in scope / BPS but are required to complete the job, shall be paid as per published schedule of rates of the Public Works Department, Government of West Bengal and schedule of rates published by the competent authority of WBSEDCL, as effective on the date of bid opening.
- (32) **Bidder should provide the rates for erection work without GST. Applicable GST will be paid in extra.**
- (33) **Award of Contract:** The bidder whose bid has been accepted will be notified by the Tender Inviting & Accepting Authority through Acknowledgement Letter / Letter of Acceptance. The notification of award will constitute the formation of the contract.
- (34) **Supply of materials:** The supply of materials, wherever applicable, including scope, applicable standards, conditions of installation, general technical requirement, general construction, special requirement, tests, Inspection, drawings & documentation, dispatch etc. shall conform to the technical specifications as enclosed. The bidder shall arrange to prepare Guaranteed Technical Particulars (GTP) as per format and drawings from the original manufacturer and to be submitted to the Controlling Officer for approval by the competent authority of WBSEDCL. The complete cost of delivering the materials shall be borne by the vendor. Consignee and other details shall be as

stated in the LOA / PO and may generally be at the respective store of WBSEDCL under the jurisdiction of the Controlling Officer.

- (35) **Additional Performance Security which shall be equal to 10% of the tendered amount must be furnished by the successful bidder if the accepted bid value is 80% or less of the estimate put to tender (L1 bid in the range of -20% to -80%). The additional Performance Security shall be submitted in the form of Bank Guarantee from any scheduled bank valid for a period of 1 (one) year, as per specified format marked 'Annexure - A' enclosed with this NIT, before issuance of the Work Order. This is in compliance of the terms of Memorandum No. 4608-F(Y) dated 18.07.2018 of the Finance department, Government of West Bengal.**

SECTION – A
INSTRUCTION TO BIDDERS

General Guidelines for e-Tendering

Instructions / Guidelines for electronic submission of the tenders online have been annexed for assisting the contractors to participate in e-Tendering.

1. Registration of Contractor:

Any intending bidder willing to take part in the process of e-Tendering will have to be enrolled & registered with the Government e-Procurement system, through logging on to <https://wbtenders.gov.in> (the web portal). The contractor shall click on the link for e-Tendering site as given on the web portal.

2. Digital Signature certificate (DSC):

Every intending bidder is required to obtain a Class-II or Class-III Digital Signature Certificate (DSC) for submission of tenders, from the approved service provider of the National Information's Centre (NIC) on payment of requisite amount. Details are available in the website. DSC is given as a USB e-Token.

- 3.** The intending bidder can search & download the Notice Inviting Tender (NIT) and tender documents electronically from the website, once he logs on using his Digital Signature Certificate. This is the only mode of collection of tender documents.

4. Submission of Tenders:

Tenders are to be submitted in online mode in the website in two folders at a time for each work, one as Technical Proposal & the other as Financial Proposal before the prescribed date & time using the Digital Signature Certificate (DSC). The documents are to be uploaded (virus free scanned copy) duly Digitally Signed. The documents will get encrypted (transformed into non readable formats).

In order to avoid any problem arising out of network error or server error, bidders are advised to submit the bid, well in advance of the last date and time of submission of the bid. WBSEDCL shall not be held responsible for any failure of Bid submission due to snag arising out of network failure.

4.1. Technical proposal:

The Technical proposal should contain scanned copies of the following in one cover (folder).

- 4.1.1 Non Statutory / Technical Document Cover file containing Certificates, Company Detail(s), Credentials and Financial Information as given in the **Table-I** of this Clause.

Note: Failure of submission of any of the above mentioned documents will render the tender to be rejected for both statutory & non statutory cover.

THE NON-STATUTORY / TECHNICAL DOCUMENTS SHOULD BE ARRANGED IN THE FOLLOWING MANNER.

Table - I

Sl. No.	Category Name	Sub-category Description	Details
01.	Certificates	Certificates	(a) PAN Card. (b) Copy of Income Tax Return for last 3 (three) financial years. (c) GST Registration Certificate. (d) Professional Tax Clearance Certificate for the last month. (e) EPF Registration Certificate and Challan for last month. (f) E.S.I Registration Certificate and Challan for last month (if applicable). (g) Valid Contractor's License (h) Valid Supervisor's Certificate of Competency
02.	Company Detail(s)	Company Detail	(a) Trade License (b) Certificate of incorporation of company (if applicable).
03.	Credentials	Credential	(a) Performance as prime contractor (having supervisor for this particular voltage level or higher) for execution of similar nature of works of Govt., Semi Govt., Govt. undertaking Organizations, Govt. Enterprises or any power utility etc. for last 7 (seven) years and details of work in hand. (b) Documents of Credential (in the form of successful work completion certificate / performance certificate containing the official memo. number & date, order number, actual date of completion and final executed value of work with other relevant information along with copy of Final Order and/or Payment Certificate) of executing similar nature of works of Govt., Semi Govt., Govt. undertaking Organizations, Govt. Enterprises or any power utility etc. in last 7 (seven) years of not less

			<p>than</p> <p>i. 3 nos. works (similar nature of works) costing not less than 40% of the estimated cost</p> <p>or</p> <p>ii. 2 nos. works (similar nature of works) costing not less than 50% of the estimated cost</p> <p>or</p> <p>iii. 1 nos. works (similar nature of works) costing not less than 80% of the estimated cost.</p>
04.	Financial Information	Financial Information	<p>a) Annual Audited Financial Report for last 3 (three) years to be submitted for verification in respect of bidders for whom Audit of Accounts is mandatory. For whom Audit of Accounts is not mandatory, they shall submit copy of Income Tax Returns along with related enclosures (Form 3CA and Form 3CB) for last 5 years.</p> <p>b) Average annual turnover during last 3 years shall not be less than 30% of the estimated cost.</p> <p>c) Working capital in the year, proceeding the year of bid submission shall not be less than 30% of the estimated cost.</p> <p>d) In case documents certifying credit facility from a scheduled bank is submitted, the requirement given in clause (c) above shall be judged by adding available credit facility and working capital taken together.</p>

Click the check boxes beside the necessary documents in the My Document list and then click the tab **“Submit Non-Statutory Documents”** to send the selected documents to Non-Statutory folder. Next Click the tab **“Click to Encrypt and upload”** and then click the **“Technical”** Folder to upload the Technical Documents.

4.2. Financial proposal:

The financial proposal should contain the following documents in one cover (folder) i.e. Bill of quantities (BOQ). The contractor is to quote the rate (Offering above / below / at par) online in the space marked for quoting rate in the BOQ.

Only downloaded copies of the above documents are to be uploaded scanned for virus and digitally signed by the contractor / bidder.

5. Opening and evaluation of tender:

5.1 Opening of Technical Proposal

- (i) Technical proposals will be opened by the Tender Inviting Authority or his authorized representative electronically from the website stated above, using their Digital Signature Certificate.

- (ii) Technical proposals for those tenders where EMD have been received within due date will only be opened. Proposals corresponding to which EMD has not been received, will not be opened and will stand rejected.
- (iii) Intending bidders may remain present, if they so desire.
- (iv) Cover (folder) for statutory documents will be opened first and if found in order, cover (folder) for non-statutory Documents will be opened. If there is any deficiency in the statutory documents, the tender will summarily be rejected.
- (v) Decrypted (transformed into readable formats) documents of the statutory and non-statutory covers will be downloaded for the purpose of evaluation.

5.2. Techno-commercial Evaluation of Tender

- (i) During evaluation, the Tender Inviting Authority or his authorized representative may summon the bidders and seek clarification / information or additional documents or original hard copy of any of the documents already submitted and if those cannot be produced within the stipulated timeframe, their proposals will be liable for rejection.
- (ii) The summary list of bidders, whose bids will be found techno-commercially eligible, will be uploaded in the web portals. Date of opening of financial bid will be intimated to the Techno-commercially qualified bidders.

5.3. Opening and evaluation of Financial Proposal

- (i) Financial proposals of the bidders declared techno-commercially eligible, will be opened electronically by the Tender Inviting Authority from the web portal stated above on the mentioned date.
- (ii) The encrypted copies will be decrypted and the rates will be read out to the bidders remaining present at that time.
- (iii) After opening of the financial proposal the preliminary summary result containing *inter alia*, the name of bidders and the rates quoted by them will be uploaded.
- (iv) The Tender Accepting Authority may ask any of the bidders to submit analysis to justify the rate quoted by that bidder.

6. Revision / withdrawal of Financial Proposal by the bidder after opening of Technical Proposal of the tender will not be allowed if it is not sought by the Tender Inviting Authority.

Enclosure:

- (1) Drawings
- (2) Technical Specifications

Regional Manager
North 24 Parganas Region
WBSSEDCL

**FORMAT OF THE BANK GUARANTEE FOR ADDITIONAL
PERFORMANCE SECURITY DEPOSIT**

.....(Designation of Engineer-in-Charge)
..... (Office address of Engineer-in-Charge)

WHEREAS (name and address of Contractor) (hereafter called "the Contractor") has undertaken, in pursuance of Contract No. Dated to (name of Contract and brief description of Works (hereinafter called "the Contract")).

AND WHEREAS it has been stipulated by you in the said Contract that the Contractor shall furnish you with a Bank Guarantee by a Scheduled Commercial Bank for the sum specified therein for 'ADDITIONAL PERFORMANCE SECURITY DEPOSIT' for compliance with his obligation in accordance with the Contract;

NOW WHEREAS we (indicate the name of the bank and branch) have agreed to give the Contractor such a Bank Guarantee.

NOW THEREFORE we (indicate the name of the bank & branch) hereby affirm that we are the Guarantor and responsible to you on behalf of the Contractor, upto a total of Rs.(amount of guarantee in words). We undertake to pay you, upon your first written demand and without cavil of argument, a sum within the limits of

..... (amount of guarantee) as aforesaid 'without your needing to prove or to show grounds or reasons for your demand for the sum specified therein.

We (indicate the name of the bank and branch) hereby waive the necessity of your demanding the said debt from the contractor before presenting us with the demand.

We (indicate the name of the bank and branch) further agree to pay to you any money so demanded notwithstanding any dispute or disputes raised by the contractor(s) in any suit or proceeding pending before any court or Tribunal.....the present absolute and unequivocal.

The payment so made by us under this bond shall be a valid discharge of our liability for payment there under and the contractor(s) shall have no claim against us for making such payment.

We (indicate the name of the bank and branch) further agree that no change or addition to or other modification of the terms of the Contract or of the works to be performed there under or of any if the Contract documents which may be made between you and the Contractor shall in any way release us from any liability under this guarantee, and we hereby waive notice of any such change, addition or modification.

We (indicate the name of the bank and branch) lastly undertake not to revoke this guarantee except with the previous consent of you in writing.

This Guarantee shall be valid upto.....It come into force with immediate effect and shall remain in force and valid for a period upto the time of completion of the work under the stated contract plus claim period of Six months for the Bank Guarantee. Notwithstanding anything mentioned above our liability against this guarantee is restricted to Rs.....(Rupees.....) and unless a claim in writing is lodged with us within the validity period i.e. upto.of this guarantee all our liabilities under this guarantee shall cease to exist.

Signed and sealed this day of
.....2021. at

by:

SIGNED, SEALED AND DELIVERED

For and on behalf of the BANK

(Signature)

(Name)

(Designation)

(Code Number)

(Address)

NOTES: (1) The bank guarantee should contain the name designation and code number of the officer(s) signing the guarantee

The address, telephone number and other details of the Head Office of the Bank as well as of issuing Branch should be mentioned on the covering letter of issuing Branch.

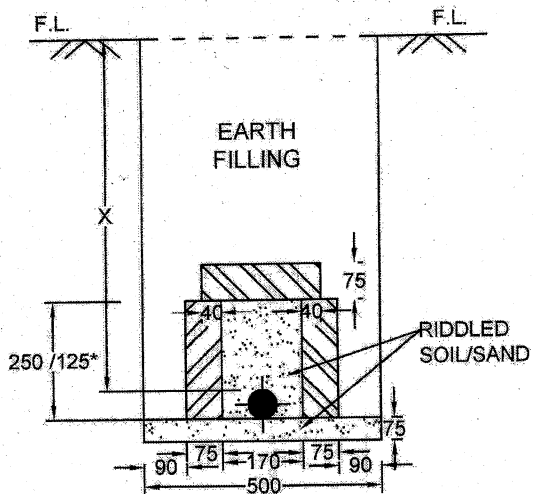

*125 FOR CABLE UPTO 1.1 KV OF SIZE	
4 CORE	150,120,95,50,25 .16SQ.MM
*250 FOR CABLE UPTO 1.1 KV OF SIZE	
4 CORE	400,300,240,185 SQ.MM
*250 FOR CABLE UPTO 11 KV OF SIZE	
3 CORE	400,300,240,185 SQ.MM

NOTES:

1. ALL DIMENSIONS ARE IN MM.
2. ONLY FIGURE DIMENSION SHOULD BE FOLLOWED
3. FOR IDENTIFICATION OF POWER CABLE, THE CABLE PROTECTIVE COVER SUCH AS BRICKS WITH TAPE MARKED WITH WORDS "WBSIEDCL" OR TILES SUITABLY EMBOSSED WITH WORDS "WBSIEDCL" SHOULD BE USED.

SCHEDULE OF DEPTH 'X'	
CABLE UPTO 1.1 KV	'X'= 750
H.T. CABLE UPTO 11KV	'X'= 900

IN CASE OF ANY CONFUSION PLEASE CONSULT DIST. P. & E. DEPT.

REVISIONS	DISTRIBUTION HQ.	
	PLANNING AND ENGINEERING DEPARTMENT	
	ARRANGEMENT FOR U.G. CABLE LAYING DIRECT IN GROUND WITH BRICK PROTECTION IN ORDINARY LOCATION.	
DRAWN BY :	Bm 04.05.2015 S.A.E.(C)	
DESIGNED BY:	05.05.15 D.E.(C)	
CHECKED BY:	J. Mayamdar S.E.(C) 05.05.15	DRAWING NO. PLN(D)/SS/104
RECOMMENDED BY:	Chakrabarty Addl. C.E. III 05.05.15	SCALE: AS STATED
APPROVED BY:	05.15 C.E. (Dist. P. & E.)	DATE: 05.05.2015
		SHEET NO. 1 OF 1
		REV. NO. 0

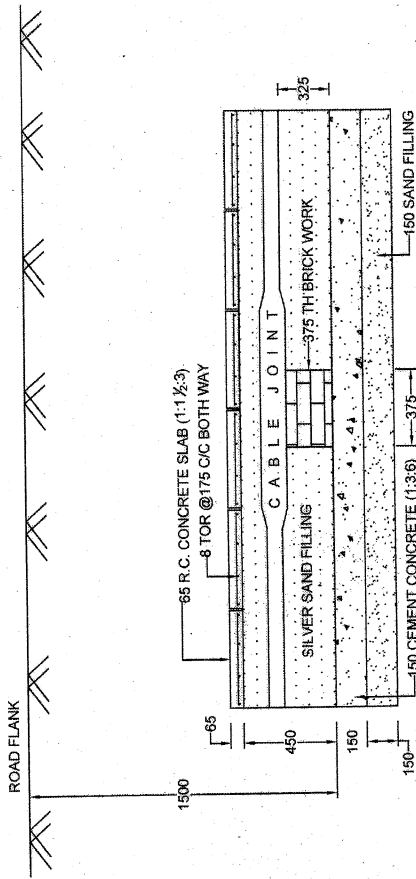

SECTION AT 'A-B'

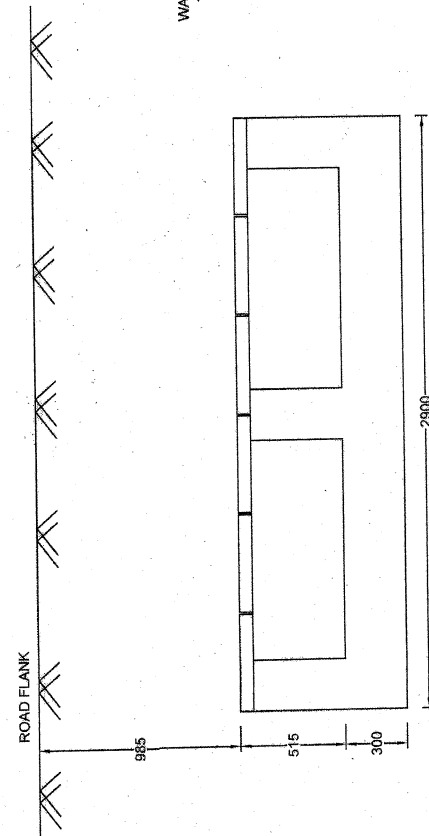

ELEVATION

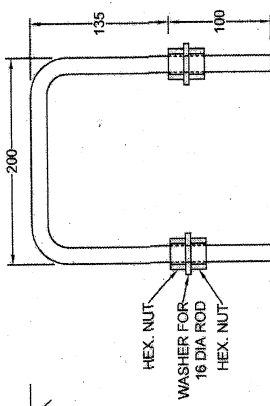

DETAILS OF LIFTING HANDLE

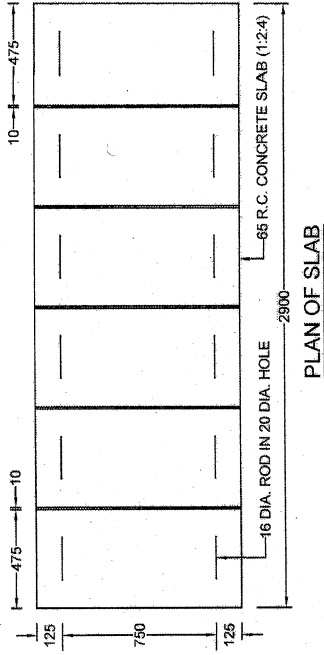

PLAN OF SLAB

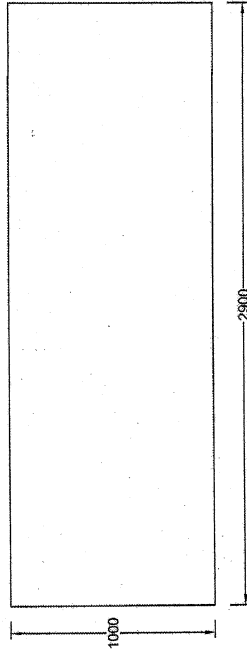

PLAN OF BOTTOM SLAB

NOTE:
1. ALL DIMENSIONS ARE IN MILLIMETER

IN CASE OF ANY CONFLICTION PLEASE CONSULT DIST. E. & E. DEPT.

REVISIONS		DISTRIBUTION HQ.
		PLANNING AND ENGINEERING DEPARTMENT
DETAILS OF PROTECTION DUCT FOR CABLE JOINT		
DRAWN BY:		
DESIGNED BY:		S.M. 04.05.2015 S.A.E.(C) D.E(C)
CHECKED BY:		S.E(C) / S.S.S.E(C) S.E(C) / S.S.S.E(C)
RECOMMENDED BY:		S.E(C) / S.S.S.E(C) S.E(C) / S.S.S.E(C)
APPROVED BY:		S.E. (DIST. P. & E.) S.E. (DIST. P. & E.)
DRAWING NO. PLND/SS/106		SCALE: AS STATED
SHEET NO. 1 OF 1		DATE: 06.05.2015
REV. NO. 0		

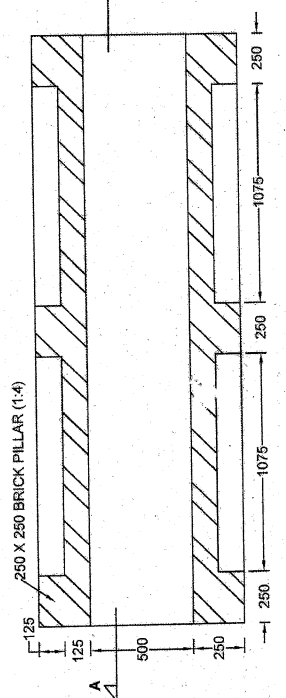

PLAN OF PROTECTION DUCT FOR CABLE JOINT

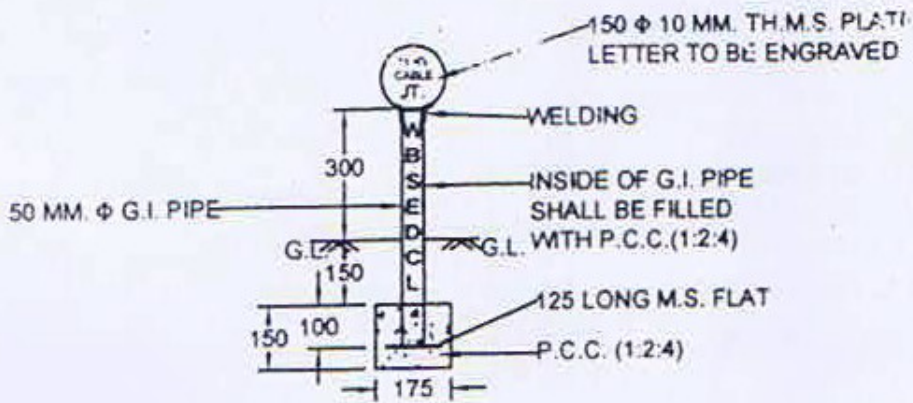

ELEVATION

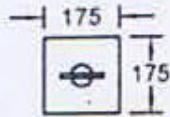

PLAN

NOTES:

1. ALL DIMENSIONS ARE IN MM.
2. ONLY FIGURE DIMENSION SHOULD BE FOLLOWED
3. THIS DRAWING SUPERSEDS DRAWING NO. -
PLN(D)/CABLE/ 04 AND PLN(D)/CABLE/ 05

IN CASE OF ANY CONFUSION PLEASE CONSULT DIST. P. & E. DEPT.

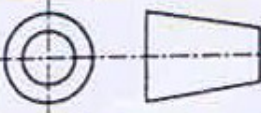
<u>REVISIONS</u>	 WBSEDCL	DISTRIBUTION HQ.	
		PLANNING AND ENGINEERING DEPARTMENT	
DETAILS OF MARKER FOR 11KV CABLE JOINT			
DRAWN BY:	<i>Bm</i> S.A.E.(C)		DRAWING NO. PLN(D)/SS/107
DESIGNED BY:	<i>A. S. S.</i> D.E.(C) 05.05.15		
CHECKED BY:	<i>J. Majumdar</i> S.E.(C) 05.05.15	SCALE:	SHEET NO.
RECOMMENDED BY:	<i>Chakraborty</i> Addl. C.E.-III 05.05.15	AS STATED	1 OF 1
APPROVED BY:	<i>S.S. 15</i> C.E. (Dist. P & E)	DATE:	REV. NO.
		05.05.2015	0